



WARN Industrial Winch

Model

**Series 9-A-48
Hydraulic Winch
Manual Clutch**

Part Number

30281

Motor Type

Hydraulic
4.9 ci
(80 cc)



The Series 9 hydraulic winch features a 2-stage planetary gear train with a total reduction of 27:1. This winch uses a heavy duty automatic disc brake and a locking clutch lever. The 4" (102mm) steel drum provides excellent durability for the wire rope. Designed to meet SAE J706 and CE standards.

Accessories

Description:	Part Number
Wire Rope Tension Plate 10"	31149
Fairlead Black 10"	24336
Fairlead Chrome 10"	30859
Remote Clutch Mechanical	38316
Remote Clutch Air	71370
Wire Rope Assembly 3/8"x125' EIPS	23674

Engineering Data

Rated Pulling Force:	9000 lbf	4082 kgf
Drum Barrel Diameter:	4.00 in	102 mm
Drum Flange Diameter:	8.24 in	209 mm
Distance Between Flanges:	9.95 in	253 mm
Recommended Maximum Wire Rope Diameter:	1/2 in	12.7 mm
Recommended Minimum Wire Rope Breaking Strength:	15,100 lbf	6849 kgf
Approximate Shipping Weight:	80.0 lb	36.3 kg
Duty Cycle (intermittent per SAE J706 section 6.2):	1034 ft	315 m
Mounting Bolt Torque:	35 - 40 ft*lb/ft	47 - 54 N*m
Maximum Layers of Wire Rope:	4 (with 3/8" dia. rope)	
Gear Reduction:	27:1	
Brake Type:	Disk	
Contactor / Remote Type:	N/A	

Drum Rotation

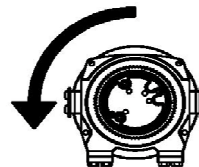

Viewed from Motor End

Standards Compliance

- 1.-SAE J706
- 2.-CE Machinery Directive 98/37/EC and 2006/42/EC

Performance By Layer- 3/8" (9.5 mm) dia. rope

Drum Layer	Line Load *			Line Speed 10 GPM		Line Speed 15 GPM		Drum Capacity	
	lbf	kgf	kN	ft/min	m/min	ft/min	m/min	ft	m
1	9000	4082	40.0	19.9	6.1	28.5	8.7	25	7.6
2	7364	3340	32.8	23.8	7.3	34.1	10.4	54	16.5
3	6231	2826	27.7	27.7	8.4	39.8	12.1	88	26.8
4	5400	2449	24.0	31.7	9.7	45.4	13.8	126	38.4

* Never exceed the Rated Pulling Force. Installation of a Rated Capacity Limiter is recommended.

First Layer Performance

Line Load		Pressure Drop at 10 GPM		Pressure Drop at 15 GPM		Duty Cycle
lbf	kgf	psi	BAR	psi	BAR	min/10min
0	0	242	16.7	358	24.7	N/A
1500	680	494	34.0	622	42.9	N/A
3000	1361	800	55.1	887	61.1	N/A
4500	2041	1110	76.5	1134	78.2	N/A
6000	2722	1388	95.7	1405	96.9	N/A
7500	3402	1710	117.9	1735	119.6	N/A
9000	4082	2050	141.3	2027	139.8	N/A

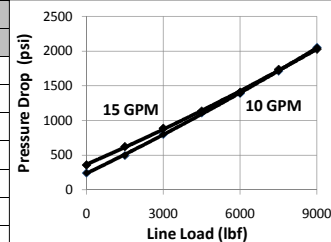
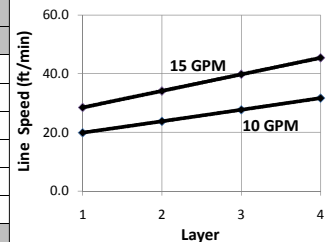

WARN INDUSTRIES, INC
Industrial Products

Customer Service (North America): 1.800.543.9276
Customer Service (International): 1.503.722.3008
FAX: 1.503.722.3000 www.warn.com

12900 S.E. Capps Road,
Clackamas, OR USA 97015



WARN Industrial Winch

Model	Part Number	Motor Type
Series 9-A-48 Hydraulic Winch Manual Clutch	30281	Hydraulic 4.9 ci (80 cc)

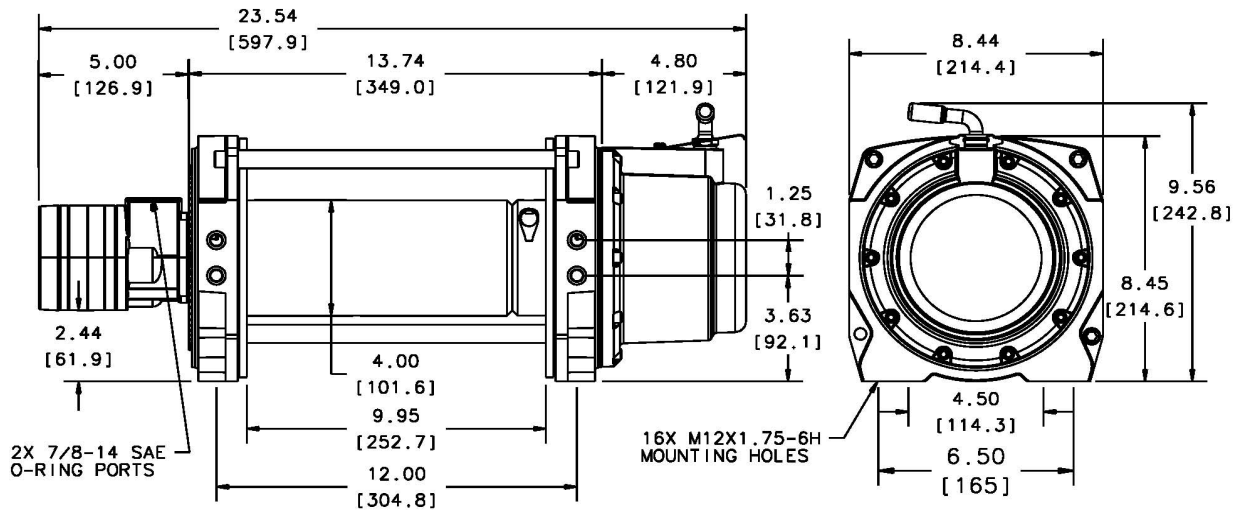

Motor / Contactor may be rotated in 180 degree increments. Clutch housing may be rotated in 72 degree increments.

Units are given in inches [millimeters], unless otherwise specified

Recommended Mounting- Always Observe Correct Drum Rotation

Hydraulic System Specifications

Pull from bottom of winch



Feet down

Pull from bottom of winch



Feet forward

Pull from top of winch

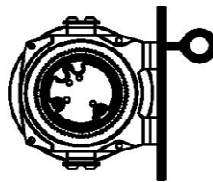

Feet forward

Pull from top of winch



Feet down without angle brace

Pull from top of winch



Feet down with angle brace

Pull from top of winch

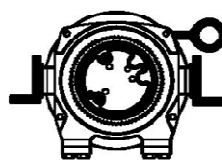

Angle Braces Only

Maximum System Pressure:	1950 psi	135 BAR
Maximum Motor Pressure Drop:	2027 psi	140 BAR
Maximum Rated Input Flow:	15 GPM	57 LPM
Control Valve Type:	3-position, 4-way, closed center, spring return (cylinder spool)	

Control Valve Schematic

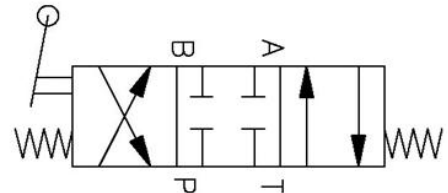

Notes:

WARN INDUSTRIES, INC
Industrial Products

Customer Service (North America): 1.800.543.9276
Customer Service (International): 1.503.722.3008
FAX: 1.503.722.3000 www.warn.com

12900 S.E. Capps Road,
Clackamas, OR USA 97015